

HHF – Flanged Housing with High-Capacitive HRB
d 12 – 100 mm

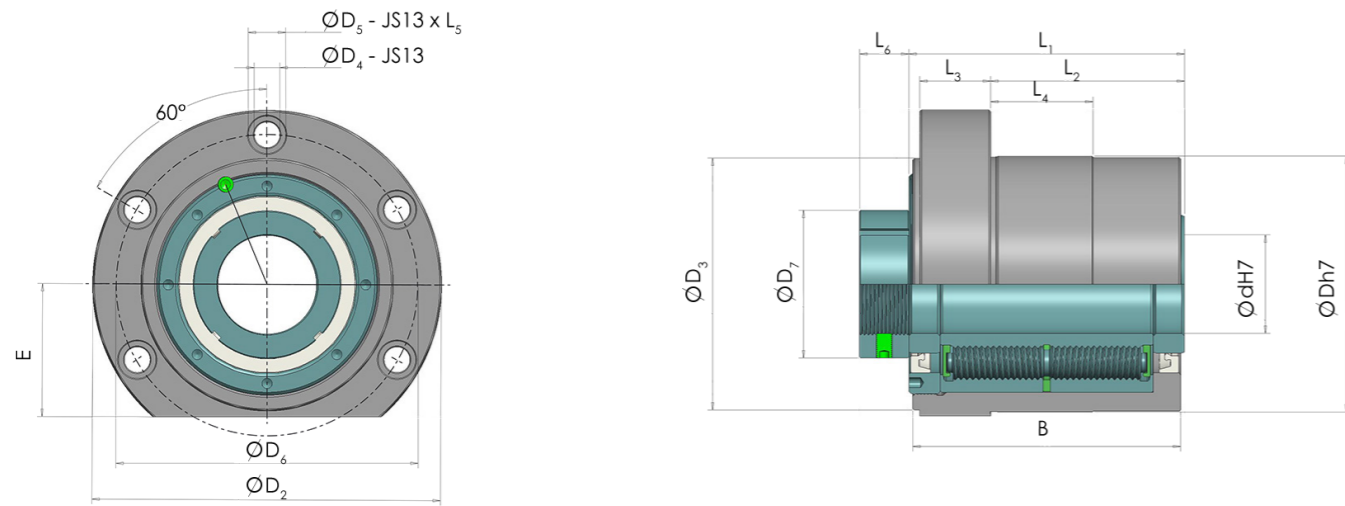

Principal dimensions			Basic load ratings		Lifetime benefit ⁽¹⁾	Speed ratings		Mass
d	D	B	C	C ₀		Reference speed	Limiting speed	
mm			kN		–	r/min		kg
12	47	40	19	17	4x	25000	29100	0.72
17	60	44	42	53	4x	17600	20500	1.16
20	60	74	138	258	50x	15000	17500	1.73
25	80	86	206	430	26x	12000	14000	3.71
35	100	106	314	736	24x	8500	10000	6.72
50	130	136	640	1483	34x	6000	7000	13.62
65	170	175	885	2399	25x	4600	5300	29.51
90	220	229	1546	5087	45x	3300	3800	60.47
100	250	245	1783	6285	31x	3000	3500	84.21

HHF – Mounting on an end shaft

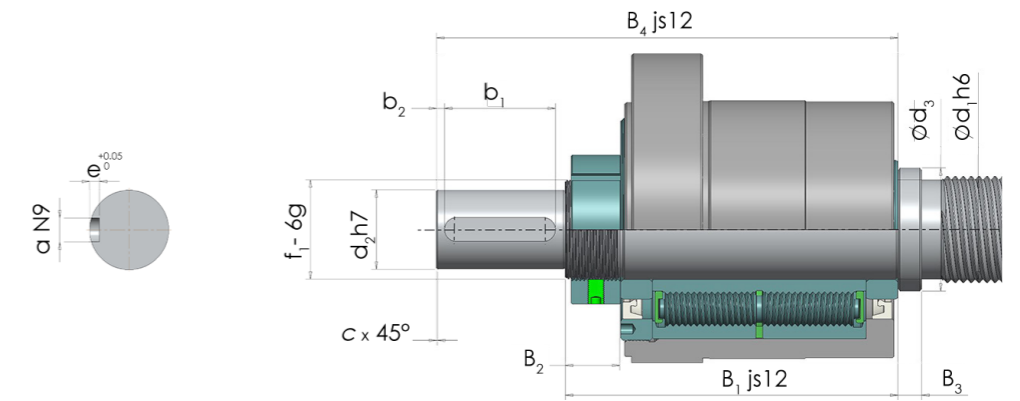

Designations Herringbone Roller Bearing	Dimensions															
	d	D	D ₂	D ₃	D ₄	D ₅	D ₆	D ₇	L ₁	L ₂	L ₃	L ₄	L ₅	L ₆	E	
–	mm															
HHF - 1	12	47	77	47	6.6	11	63	22	42	25	12	10	2	8	27	
HHF - 2	17	60	92	57	6.6	11	76	28	46	32	12	15	2	10	32	
HHF - 3	20	60	92	58	9	14	74	38	77	60	15	27	2	10	32	
HHF - 4	25	80	122	74	11	17	100	45	89	68	19	33	3	20	44	
HHF - 5	35	100	144	94	13	19	120	58	110	82	25	42	5	22	54	
HHF - 6	50	130	177	128	13	19	152	75	140	98.5	36	52	11	25	67	
HHF - 7	65	170	230	164	17	25	198	105	180	133.5	41	50	11	32	87	
HHF - 8	90	220	292	215	22	32	252	130	235	179	48	94	13	38	115	
HHF - 9	100	250	330	240	25	38	285	140	253	195	50	109	14	38	130	

Designations Herringbone Roller Bearing	End Shaft Dimensions													
	d ₁	d ₂	d ₃	B ₁	B ₂	B ₃	B ₄	f ₁	c	b ₁	b ₂	a	e	
–	mm													
HHF - 1	12	10	17	51	10	5	71	M12 x 1.0	0.5	16	1.5	3	1.8	
HHF - 2	17	15	23	66	21	5	96	M17 x 1.0	0.5	25	2.0	5	3.0	
HHF - 3	20	17	27	98	22	7	138	M20 x 1.0	0.5	32	3.0	5	3.0	
HHF - 4	25	20	34	111	24	7	156	M25 x 1.5	1.0	40	2.5	6	3.5	
HHF - 5	35	30	45	134	26	10	189	M35 x 1.5	1.0	45	2.5	8	4.0	
HHF - 6	50	40	62	168	30	12	233	M50 x 1.5	1.0	56	4.0	12	5.0	
HHF - 7	65	60	78	215	37	18	315	M65 x 2.0	1.0	90	3.0	18	7.0	
HHF - 8	90	85	108	275	43	25	395	M90 x 2.0	1.0	100	8.0	25	9.0	
HHF - 9	100	95	120	293	43	25	433	M100 x 2.0	1.0	125	7.0	25	9.0	

(¹): It compares the bearing unit with the best competitor solution of the same dimensions

